



# GUOYEXING OPTOELECTRONICS CO.LTD

## SPECIFICATION

FOR APPROVAL

ISSUED DATE :

CUSTOMER :

DESCRIPTION :

MODEL NO.: GYX-1588ASRG-MZ

DOCUMENTNO. :

[ GUOYEXING TECH. ]

ISSUE	REVIEW	APPRL

[ CUSTOMER APPROVAL ]

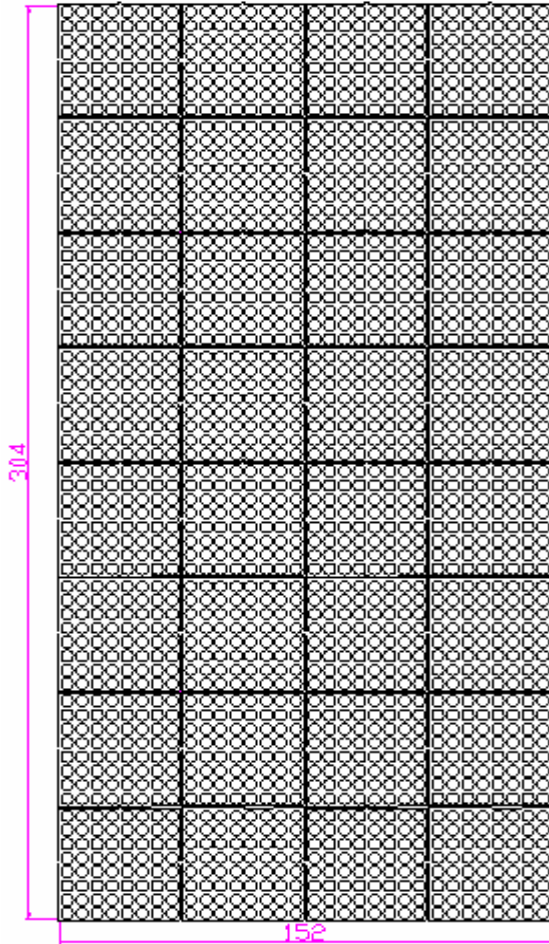

**\*DATE—CONNECTOR (JIN1, JOUT1)**



PIN NO	SIGNAL	PIN NO	SIGNAL
1	GND	2	LA
3	GND	4	LB
5	GND	6	LC
7	EN	8	LD
9	R1	10	G1
11	R2	12	G2
13	GND	14	LT
15	GND	16	SK

**\*POWER CONNECTOR (J POWER1)**

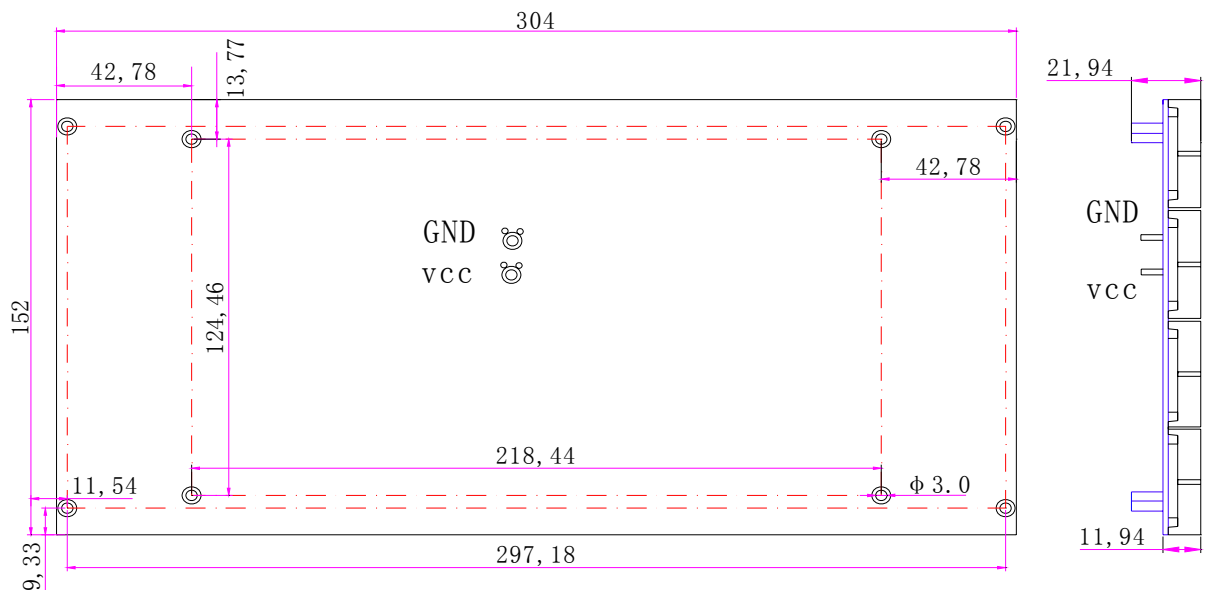
NO	SIGNAL	LEVEL
1	VCC	5 (V)
2	GND	0 (V)



This module designed for light emitting display device. Organize with 32x64 matrix combination with 2048of Red(1), YG(1), lamps , for indoor use.

### 1、 FEATURE

Active display size	152mm×304mm
Dot size	3.75mm
Dot pitch	4.75mm
Display color	Red, Y-Green
Drive type	1/16 SCAN
Dot matrix	2048(32×64)
Weight	550g

### 2、 ABSOLUTE MAXIMUM RATINGS

Ta=25℃

ITEM	SYMBOL	RATING	UNIT	COND
Power dissipation	PD	35W	W	
Supply voltage	Vcc	5	V	
Operating Temp	Topr	-20~+60	℃	
Storage Temp	Tstg	-20~+65	℃	

### 3、 GUARANTEE TEMPERATURE FOR OPERATING

ITEM	ATMOSPHERIC TEMP	REMARK
Work Temp	-20~+53℃(Max)	50% Lit
Storage Temp	-20~+60℃(Max)	25% Lit

### 4、 DISPLAY CHARACTERISTICS

- 4-1. Half viewing angle —————±50° /25°
- 4-2. Brightness of emission area.(when black-out) —————Clear
- 4-3. Brightness of non-emission area —————Black

**5、 OPTICAL CHARACTERISTICS**

Ta=25°C

ITEM		SYMBOL	COND	MIN.	TYP	MAX	UNIT
Brightness	RED	IVr	Vcc=5V	95	115	135	Cd/m²
	Y-GREEN	IVg					

(\*1)

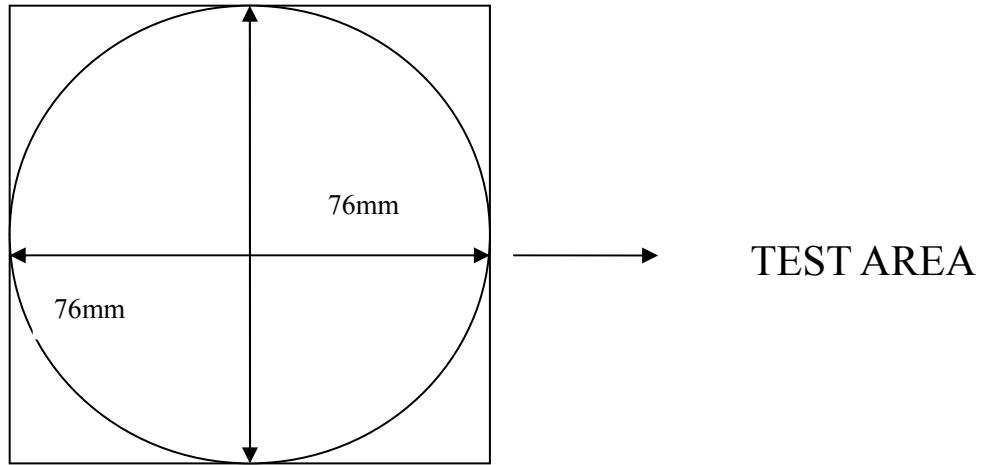

**6、 ELECTRICAL CHARACTERISTICS**

**6-1.Voltage-Current Characteristics**

Ta=25°C

ITEM	SYMBOL	COND	MIN	TYP.	MAX	UNIT
Supply voltage(LOGIC)	Vcc	—		5		V
Supply current(LOGIC)	Icc	Vcc=5V	—	200		mA
Supply current(Led)	Iled			7		A

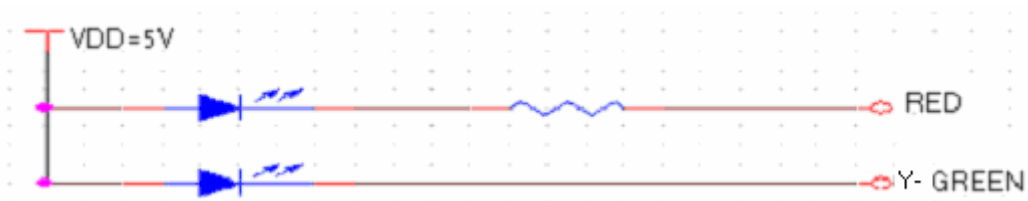

**7. OTHER ITEM**

**7—1. Connection example between products**

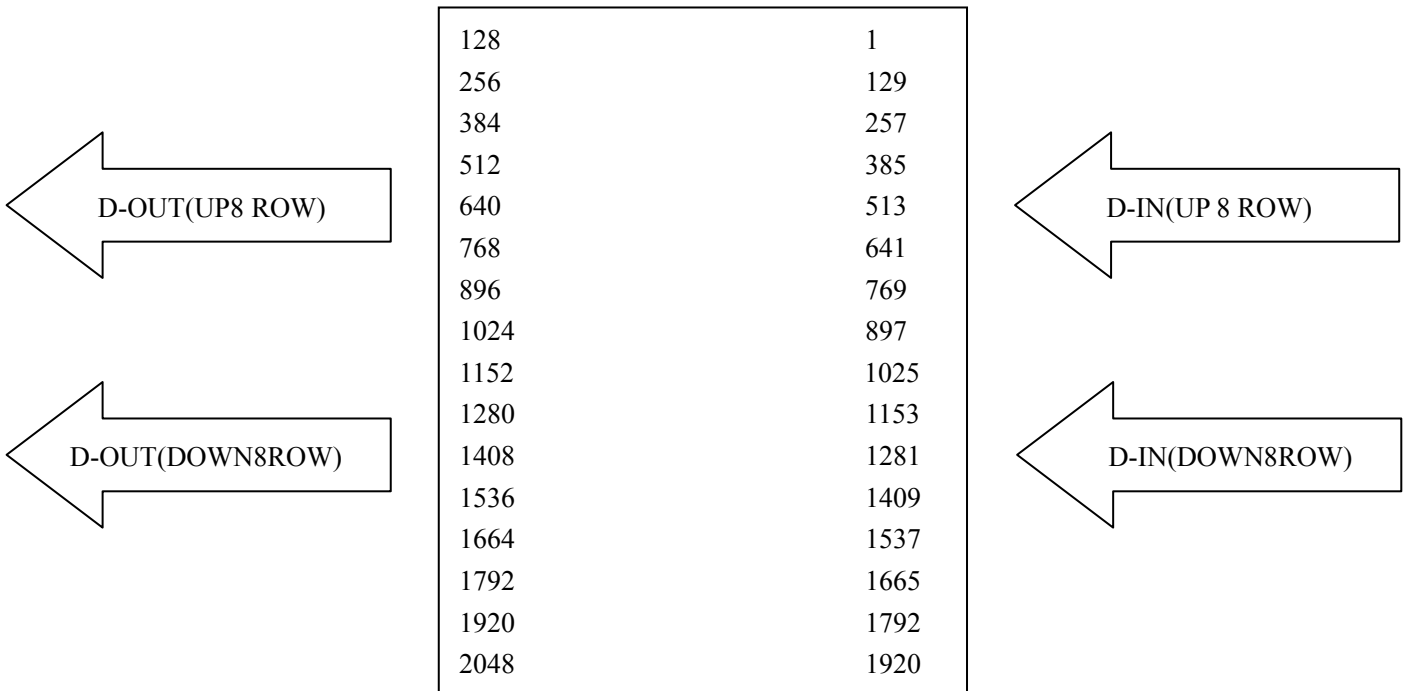
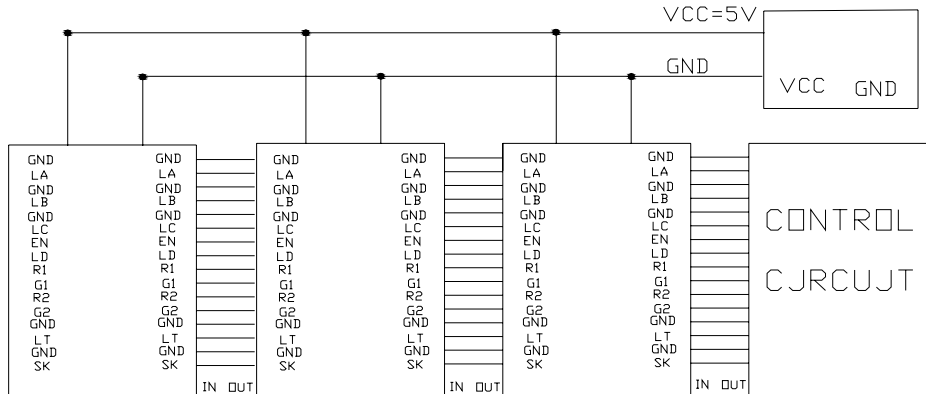

## 8. INTERFACE

### 8-1.IN/OUT PUT connector pin number & signal function

PORT	Pin No.	SIGNAL	SIGNAL-FUNCTION
INPUT/ OUTPUT SIGNAL (IN)	1	GND	GROUND
	2	LA	HORIZONTAL SCAN ADDRESS 0
	3	GND	GROUND
	4	LB	HORIZONTAL SCAN ADDRESS 1
	5	GND	GROUND
	6	LC	HORIZONTAL SCAN ADDRESS2
	7	EN	OUTPUT ENABLE
	8	LD	HORIZONTAL SCAN ADDRESS 3
	9	R1	RED DATA (UP 8 ROW)
	10	G1	GREEN DATA (UP 8 ROW)
	11	R2	RED DATA (DOWN 8 ROW)
	12	G2	GREEN DATA (DOWN 8 ROW)
	13	GND	GROUND
	14	LT	DATA LATCH
	15	GND	GROUND
	16	SK	SHIFT CLOCK

### 8-2. Power connector pin number & signal function

NO	SIGNAL	LEVEL	FUNCTION	WIRE
1	VCC	5 [V]	POWER OF LED	RED
2	GND	0 [V]	GROUND	BLACK

9.BLOCK DIAGRA

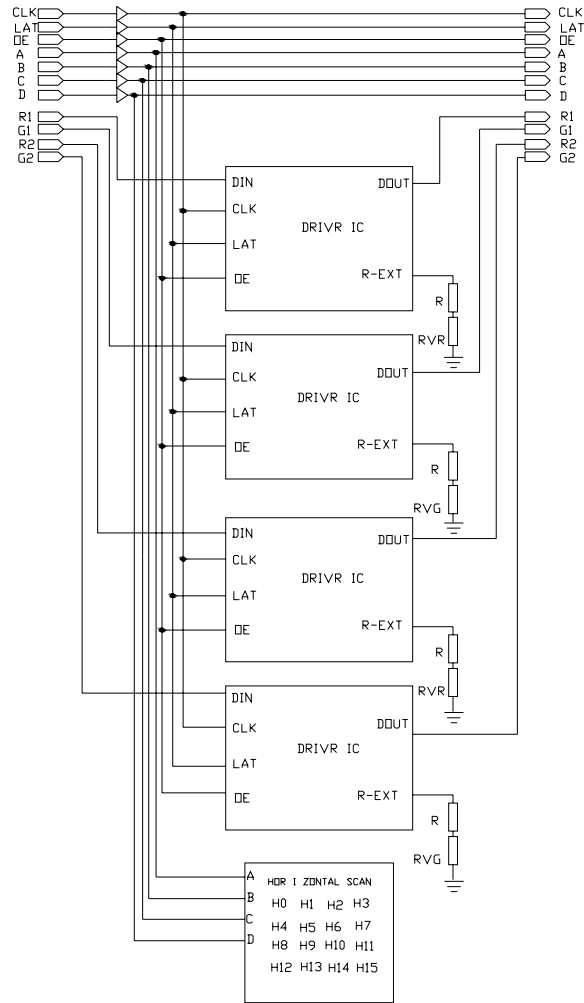

ROUT1	ROUT2	ROUT3	ROUT4
{1:8}	{1:8}	{1:8}	{1:8}
<b>LED ARRAY</b>			
<b>(32×64)</b>			
GOUT1	GOUT2	GOUT3	GOUT4
{1:8}	{1:8}	{1:8}	{1:8}

<b>MODEL NO</b> GYX-1588ASRG-MZ	<b>PAGE</b> 7/9
------------------------------------	--------------------

10. CABLE SPEC

<POWER CABLE>

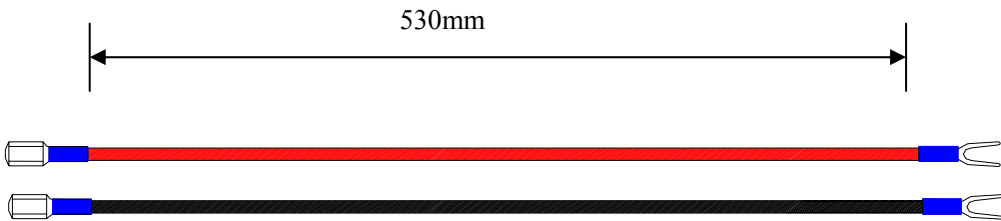

<SIGNAL CABLE>

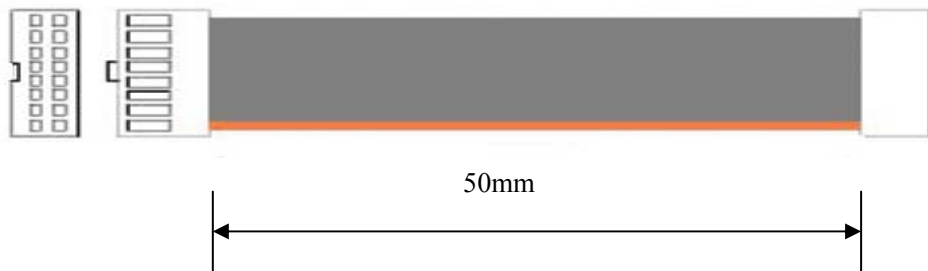

PART NO.	STANDARD	VENDOR
FL01-14D-50mm	2.54mm PITCH 16 P WIRE (FLAT CABLE/50mm)	
Gu396-0418-300R	4mm PITCH 4 P WIRE	

<b>MODEL NO</b> GYX-1588ASRG-MZ	<b>PAGE</b> 8/9
------------------------------------	--------------------

---

11. PART LIST

NO	PART LIST	DWG NO	QUAN.	TYPE	PART NAME	MAKER	NOTE
1	MODULE		32	1588ASRG			
2	PCB(Display)		1	GYX1588ASRGPCB			152mm*304mm
3	DRIVE IC		32	SOP-16	74HC595		
4	IC		2	SOP-20	74HC244D		
5	IC		2	SOP-16	74HC138D		
6	IC		1	SOP-14	74HC04D		
7	TRANSISTOR		8	SOP-8	CEM4953		
8	CAPACITANCE		4	DIP	470uF/16V		POWER
9	CAPACITANCE		21	SMC	104		
10	RESISTANCE		1	SMC	4.7K $\Omega$		
11	RESISTANCE		4	SMC	100 $\Omega$		
12	EXCLUSION		1	SMC	1K $\Omega$		
13	EXCLUSION		1	SMC	3.9K $\Omega$		
14	EXCLUSION		4	SMC	100 $\Omega$		
15	Filling-in bits		2				
16	SCREW		8		M3*10		
17	NUT		8		$\phi$ 3		
18	POWER LINE		1		2..5 m <sup>2</sup> (530mm)		

---

<b>MODEL NO</b> GYX-1588ASRG-MZ	<b>PAGE</b> 9/9
------------------------------------	--------------------

---

## 12. INSTALLATION NOTICES

- 1) Please apply this modules at a safe surrounding against noise because the error or mis-operation may occur at fragile place of noise.
- 2) Check surely the power condition to operation test in order to prevent module damage which might be caused by the excessive power.
- 3) Modules should be set up within the guarantee limitation and especially kept away from salt dust, soot and SO<sub>2</sub> gas etc.
- 4) When there is no data transmission at operation test just turn power off immediately. Otherwise operating gets damaged.
- 5) Please apply this product under the range of guarantee, considering the sufficient radiation in case of the assembled multi-module.
- 6) V led is recommended the maximum of rating voltage for best result under the low temperature such as -15° C below.
- 7) Please check the insert direction when you attach SIGNAL CONNECTOR or link the power.

## 13 .REFERENCES

- 1) Check SYSTEM weight before apply modules into housing.
  - 2) Operation test or anti-static electricity need for the COMS attached in circuit board.
  - 3) Sufficient power capability is necessary to deal with the excessive power which might be drastically caused depending on the condition of the on/off of unit.(peak current times 1.5 and higher)
  - 4) power for logic or LED requires Switching Mode Supply.
  - 5) Use power bus bar when connecting power. It helps power to keep from falling down..
  - 6) Please don't change "switch was set as outgoing" The switch was set as out-going.
  - 7) Any further question or trouble herein will be worked out mutually by customer and supplier through sales manager.
-