



SPECIFICATION FOR APPROVAL

Customer: _____

Description: LED LAMP

Model: GL-5P1URAD-T

Lot No.: _____

No.: _____

Date: 2008-08-06

Enclosure is the specification

SHENZHEN GUOYEXING OPTOELECTRONICS CO., LTD.			
Production Dept.	Quality Dept.	Engineering Dept.	Marketing Dept.

APPROVED SIGNATURES			

Add: 4/F, Block C, Dongjiaotou Industrial Zone, Houhai Avenue, Shekou, Shenzhen,

Tel: 0086-755-26895486, 26895484

Fax: 0086-755-26895481

Email: gyx@gyx-led.com

Website: www.gyx-led.com



GL-5P1URAD-T

RED

Features

- 1) 3.8*5.2*7mm ELLIPSE LAMP
- 2) LOW CURRENT REQUIREMENT
- 3) LOW POWER CONSUMPTION
- 4) VERSATILE MOUNTING ON P.C. BOARD PANEL
- 5) LONG LIFE-SOLID STATE RELIABILITY

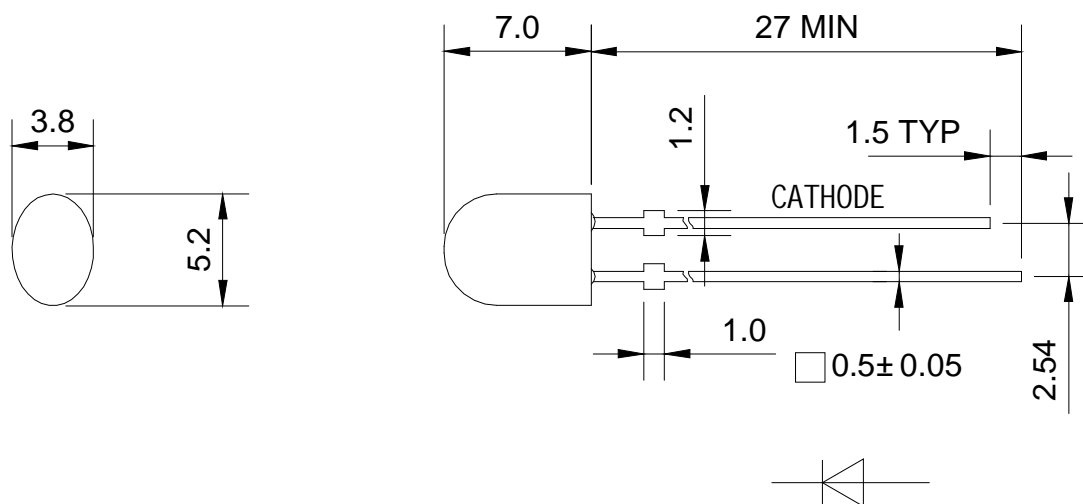
Package Dimensions**RED****Notes:**

1. All dimensions are in millimeters.
2. Tolerance is ± 0.25 unless otherwise noted.
3. Specifications are subject to change without notice.



3.

Part No.	Chip Material	Emitting Color	Lens Type	Iv(mcd)@20mA			Viewing Angle
				Min.	Typ.	Max	
GL-5P1URAD-T	AlGaInP	Red	RedDiffused	446	580	754	2 θ 1/2 68/32°

Note:

θ 1/2 is the angle from optical centerline where the luminous intensity is 1/2 the optical centerline value.

4. Electrical / Optical Characteristics at T_A=25° C

Parameter	Symbol	Min.	Typ.	Max.	Units	TestConditions
Forward Voltage	V _F	1.8	2.0	2.5	V	I _F =20mA
Peak Wavelength	λ _p	627	631	636	nm	I _F =20mA
Dominate Wavelength	λ _D	615	620	625	nm	I _F =20mA
Spectral Line Half-width	Δ λ	-	17	-	nm	I _F =20mA
Reverse Current	I _R	-	-	10	uA	V _R =6V

5. Absolute Maximum Ratings at T_A=25° C

Parameter	Symbo	Maximum Rating	Units
Power dissipation	P _d	75	mW
Forward Current	I _F	30	mA
Peak Forward Current (1)	I _F (Peak)	130	mA
Reverse Voltage	V _R	6	V
Operating Temperature	T _{opr}	-40° C To +80° C	
Storage Temperature	T _{stg}	-40° C To +80° C	
Lead Solder Temperature(2)	T _{sol}	260° C for 3 seconds	

Note:

- 1) 1/10 Duty Cycle, 0.1ms Pulse Width.
- 2) 3mm below package base.
- 3) The production accord with the demand of ROHS.



Relative Intensity Vs Wavelength Chart

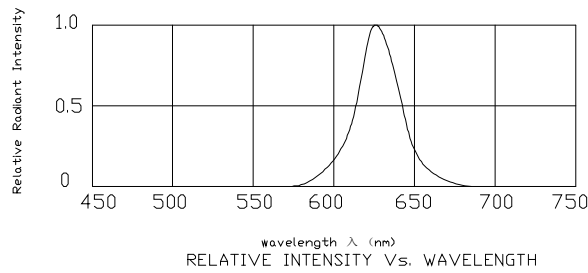

(GL-5P1URAD-T)

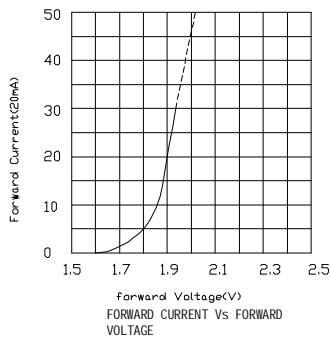

正向电流与正向电压关系曲线图

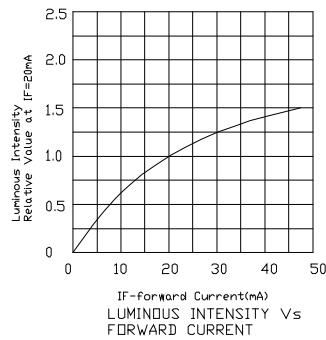

亮度与正向电流关系曲线图

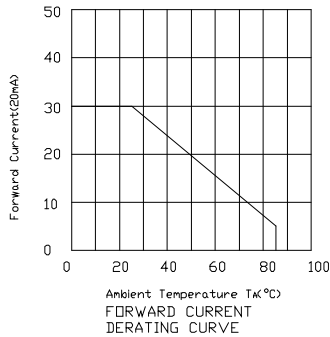

正向电流递减曲线图

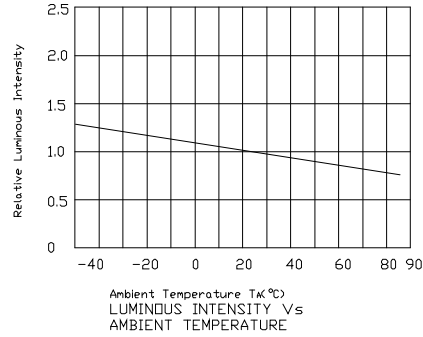

亮度与环境温度关系曲线图

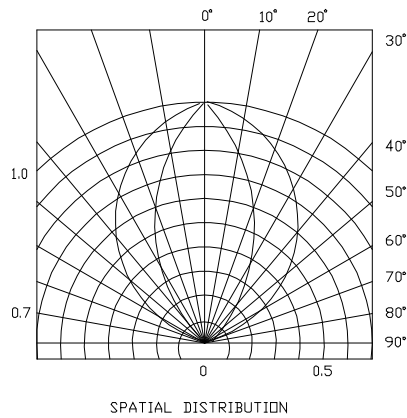



RELIABILITY

(1) TEST ITEMS AND RESULTS

Type	Test Item	Test condition		Note	Sample size	Accept
		Test condition	Test condition			
(Environments Sequence)	Thermal shock	-20°C~80°C 15min, 10s, 15min	-40°C~100°C 15min, 10s, 15min	100 cycles	20~560	0
		190°C~240°C 5min		1 cycles	20~560	0
		240°C~260°C 5sec		1 cycles	20~560	0
(Operation Sequence)	Life test	Ta=25°C If=20mA	Ta=25°C If=20mA	1000Hrs	20~560	0
(Destructive Sequence)		Ta=100°C		60 minutes	10~20	0

Reflow Soldering Instructions

Number of reflow process shall be less than 2 times and cooling process to normal temperature is required between first and Second soldering process.

1>Lead Solder

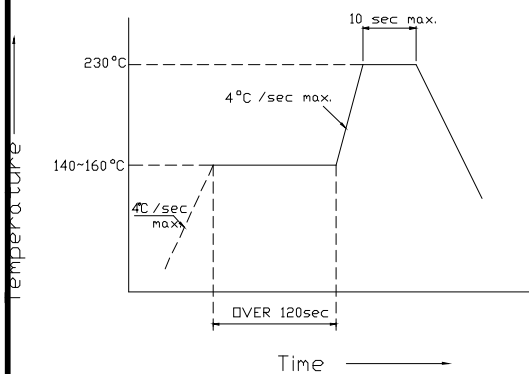

2>Lead-Free Solder

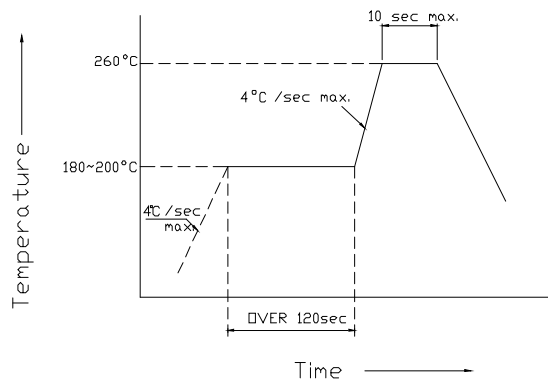



Intensity And Color Bin Limits

(1) Intensity Bin Limits (If=20mA)

SELECTION CODE FOR SUPER BRIGHT LEDS		
Group	Light intensity in mcd(20mA) Super Bright Red	
	Min.	Max.
P	325	420
Q	420	545
R	545	705
S	705	915

Tolerance for each Bin limit is $\pm 10\%$

(2) Color Bin Limits (If=20mA)

COLOR CODE FOR RED LEDS + DISPLAYS		
Group	Dom. WaveLength (nm)	
	min.	max.
F2	615	620
G2	620	625
H2	625	630

Tolerance for each Bin limit is ± 1 nm.

Forward Voltage Bin limits(If=20mA)

Grade (等级)	A3	B3	C3	D3	E3
Range (范围)	1.6-1.8	1.8-2.0	2.0-2.2	2.2-2.4	2.4-2.6

Tolerance for each Bin limit is ± 0.05 v.